

# ENDURALINE

Built to last 100,000 hours

JOB NAME:

TYPE:

CATALOG #:

## GENERAL DESCRIPTION:

Utilizing a high quality aluminum reflector, **IHB-AL Series** is suitable for both Highbay and Lowbay applications. Achieving superior lighting overall, this series reduces both lighting and HVAC loads, and is extremely suitable for areas requiring maximum longevity and minimal maintenance.

## HOUSING:

Heavy duty die cast aluminum housing with surface fins for maximum heat dissipation. Stainless steel fasteners.

## OPTICS:

**AL-** Precision spun aluminum reflector, finished in high reflectance white for maximum efficiency, smooth even illumination, reduced glare, and 100% downlight.. **Optional** clear Flat glass (**FG22**) lens.

## MOUNTING:

The Integral junction/splice box is used for wire terminations and luminaire suspension. Three quarter inch hub accepts either conduit or **ENDURALINE** threaded support hooks. All units should be installed by a licensed electrical contractor in accordance with NEC guidelines.

## ELECTRICAL / BALLAST:

Rated for 100,000 hrs, a 100% high frequency electronic ballast with .99pf, < 10% THD, Sound Rated A, and compliance with FCC EMI regulations. Operating temperatures of -35c to 90c and voltages of 120v or 277v. All wiring to be AWM, TFN, or THHN to comply with rated temperature requirements.

## LAMP:

19200 lumens (80 lpw), rated for 100000 hrs, a CRI of 85, flicker free instant starting with optional Kelvin temperatures of 2700-6500k in color.

## FINISH:

White finish standard for maximum heat dissipation.

## LISTINGS / WARRANTY:

All products are UL listed and carry a 5 Year limited warranty. **Optional 10 year warranty available.**

**NOTE:** Specifications' SUBJECT TO CHANGE WITHOUT NOTICE.

## INDUCTION 22" HIGHBAY IHB-AL SERIES

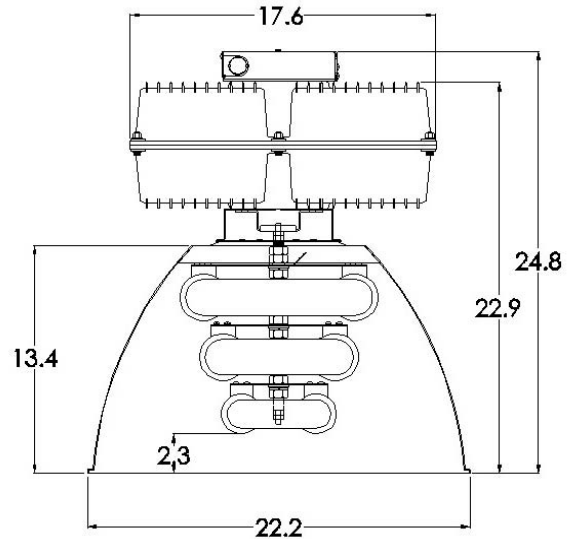

## ORDERING INFORMATION

**Example:** IHB22-AL-240-4-277

SERIES	OPTICS	WATTS	COLOR	VOLTAGE
IHB22	AL	240	2 (2700k)	120
	ALUMINUM		3 (3500k)	277
			4 (4100k)	
			5 (5000k)	
			6 (6500k)	

## OPTIONS:

3' HOOK, CORD, PLUG  
SWITCHING

HCP (Specify Voltage)  
DC (Dual circuit)  
TC (Triple Circuit)

## ACCESSORIES

HOOK  
WIREGUARD  
FLAT GLASS LENS

HK  
WGAL22  
FG22