

ENDURALINE

Built to last 100,000 hours

JOB NAME:

TYPE:

CATALOG #:

GENERAL DESCRIPTION:

Utilizing a high performance acrylic refractor, **IHB-AC Series** is suitable for both Highbay and Lowbay applications. Achieving superior lighting overall, this series reduces both lighting and HVAC loads, and is extremely suitable for areas requiring maximum longevity and minimal maintenance.

HOUSING:

Heavy duty die cast aluminum housing with surface fins for maximum heat dissipation. Stainless steel fasteners.

OPTICS:

AC-Injection molded, heat and UV resistant 22" acrylic refractor. Precisely designed prism design maximizes overall luminaire efficiency and provides for up to 18% uplight eliminating dark ceilings. **Optional** Conical (**C22**) lens, Drop (**D22**) injection molded lens, or Flat clear (**F22**) lens.

MOUNTING:

The Integral junction/splice box is used for wire terminations and luminaire suspension. Three quarter inch hub accepts either conduit or **ENDURALINE** threaded support hooks. All units should be installed by a licensed electrical contractor in accordance with NEC guidelines.

ELECTRICAL / BALLAST:

Rated for 100,000 hrs, a 100% high frequency electronic ballast with .99pf, < 10% THD, Sound Rated A, and compliance with FCC EMI regulations. Operating temperatures of -35c to 90c and voltages of 120v or 277v. All wiring to be AWM, TFN, or THHN to comply with rated temperature requirements.

LAMP:

25600 lumens (80 lpw), rated for 100000 hrs, a CRI of 85, flicker free instant starting with optional Kelvin temperatures of 2700-6500k in color.

FINISH:

White finish standard for maximum heat dissipation.

LISTINGS / WARRANTY:

All products are UL listed and carry a 5 Year limited warranty. **Optional 10 year warranty available.**

NOTE: SPECIFICATIONS'S SUBJECT TO CHANGE WITHOUT NOTICE.

INDUCTION 22" HIGHBAY IHB-AC SERIES

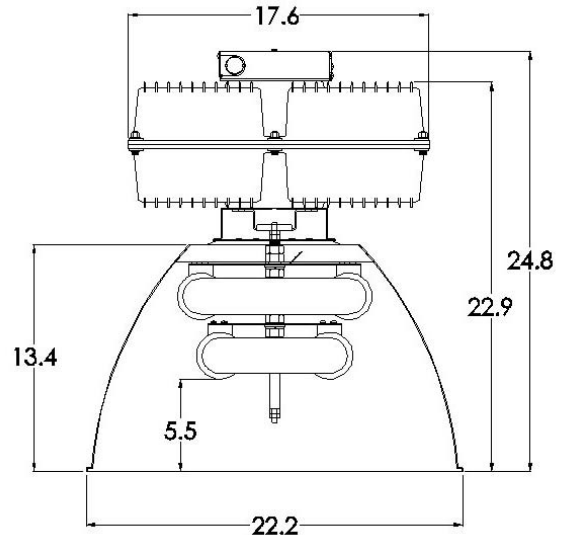

ORDERING INFORMATION

Example: *IHB22-AC-320-4-277*

<u>SERIES</u>	<u>OPTICS</u>	<u>WATTS</u>	<u>COLOR</u>	<u>VOLTAGE</u>
IHB22	AC ACRYLIC	320	2 (2700k)	120
			3 (3500k)	277
			4 (4100k)	
			5 (5000k)	
			6 (6500k)	

OPTIONS:

3' HOOK, CORD, PLUG
SWITCHING

HCP (Specify Voltage)
DC (Dual circuit)
TC (Triple Circuit)

ACCESSORIES

HOOK
WIREGUARD
FLAT LENS
CONICAL LENS
DROP LENS

HK
WGAC22
F22
C22
D22